

# Contract Furniture Collection



## Mayfair Furniture

11 Royce Road,  
Fengate Industrial Est.  
Peterborough,  
PE1 5YB, Cambridgeshire

01733 310 115

[sales@mayfairfurniture.co.uk](mailto:sales@mayfairfurniture.co.uk)

<http://mayfairfurniture.co.uk>

 MAYFAIR  
FURNITURE

# Welcome.....

**Mayfair furniture Ltd** is a specialist manufacturer and supplier offering high-quality hospitality furniture, paying particular attention to your needs for a relaxed atmosphere and individual style. Our wide selection of different materials and contrasting styles means that we can offer exactly what you're looking for to create your perfect image for your business.

We pride ourselves in providing our customers with reliable and expert advice. With our know-how and experience, you can be sure that by choosing **Mayfair Furniture** you are making the best decision for quality, service and price for your venue.

**Mayfair Furniture** is the UK's fastest growing supplier of contract commercial grade furniture to the hospitality and leisure industries. We keep in stock a huge variety of items ready for immediate dispatch, and can fulfill a wide range of bespoke orders. We deliver to all areas of the UK, Ireland & Europe

Based from our purpose-built workshops in Peterborough, Cambridgeshire, our team of Sales, Upholsterers, Joiners, and Drivers will make sure that we design, manufacture, and deliver your products on time and to the highest quality. With our objective of supplying high-quality furniture at affordable prices on time, we have had the pleasure of doing work for Pinewood Studios and Warner Brother Studios for onset seating for Jurassic World 2 and Spiderman – Far From Home, as well as supplying prestigious companies with the likes of Hilton Hotels, Colchester Hospital, Crowne Plaza Hotels, and Waterloo Housing Group.

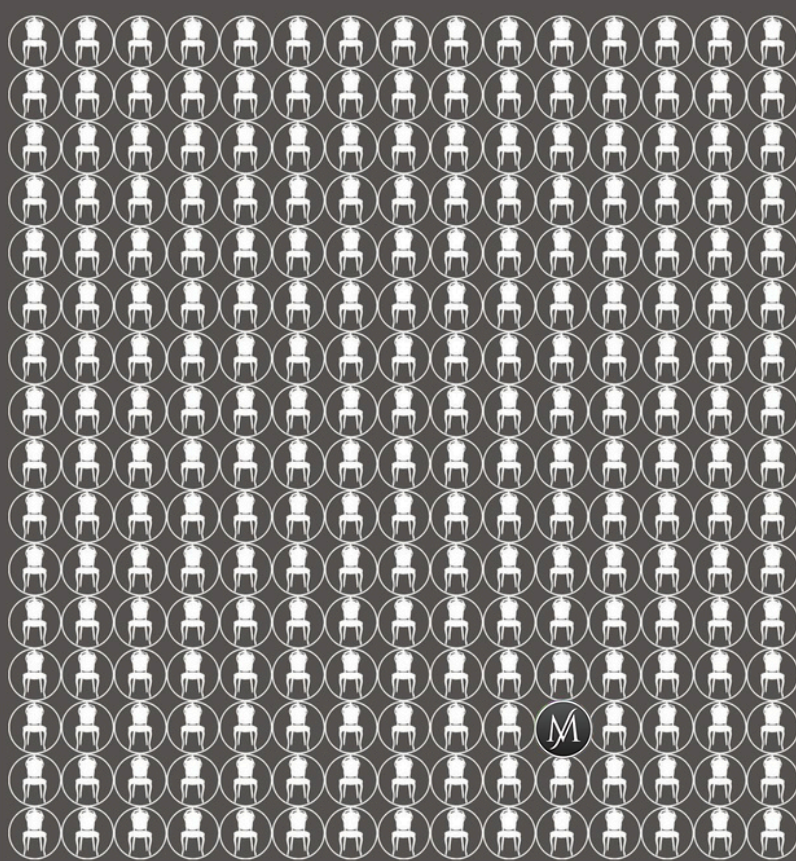

## Contact

Call : 01733 310 115

Email : [sales@mayfairfurniture.co.uk](mailto:sales@mayfairfurniture.co.uk)

Visit : <http://mayfairfurniture.co.uk>

# CONTENTS

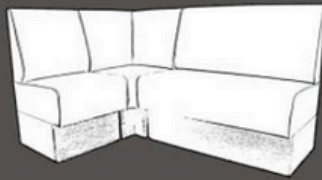

04 - 19

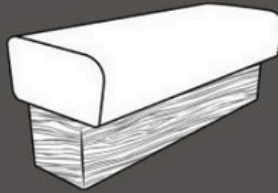

21 - 23

M



# Modular Banquette Seating



Modular Banquette Seating

# Deep Buttoned Back



Nothing says luxury more than deep buttoned furniture, a traditional method of upholstery that has never gone out of fashion.

Mix up the colours of this traditional design and suddenly you have a contemporary modern piece of furniture.

And we do it properly..... No sewn in pleats here, every single button is hand pleated and buttoned by our expert team of upholsterers.

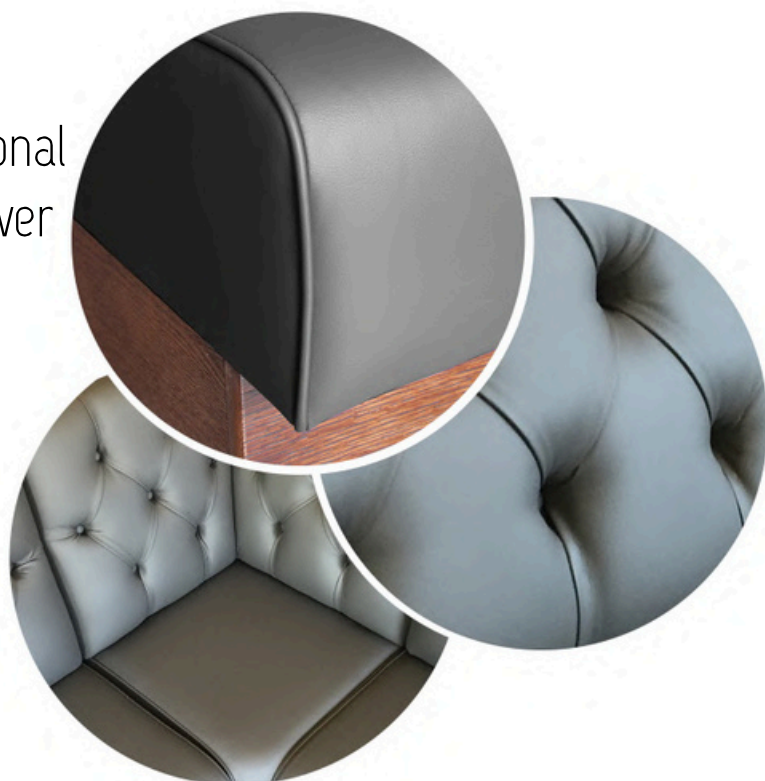

Modular Banquette Seating

# Fluted Back



Bold, Crisp & Clean Lines.....  
Our Curvaceous Fluted seating has every flute individually sewn and filled to give you the perfect curve.

So perfect it didnt take long to catch the eyes of Hollywood, recently appearing in "Spiderman - Far From Home."

Choose a custom velvet for a retro look or a solid colour faux leather for something ultra modern or really mix it up with contrasting red & white for that American Diner look.

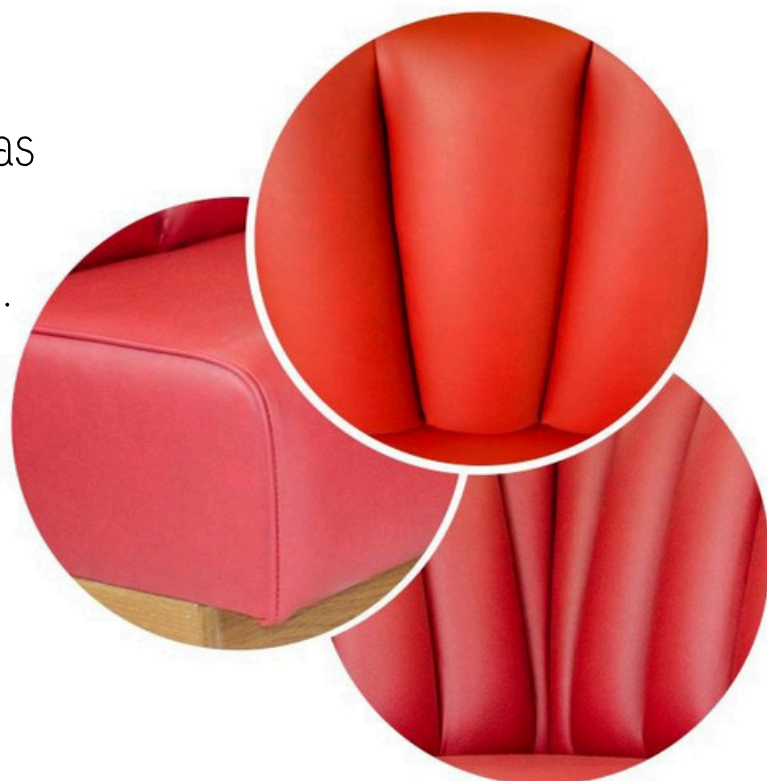

Modular Banquette Seating

# Plain Back



Simplicity, is the ultimate sophistication  
"Leonardo Da Vinci"

Our plain back seating goes the extra mile, we beautifully sew multiple sections together to give clean, crisp lines. Not just wrapping the fabric around losing the distinct shape.

We make a perfectly fitting sleeve and slide on to ensure every angle and line is as beautiful as originally designed. Every angle has a piped edge to ensure it stays pronounced and square.





# Modular Banquette Seating

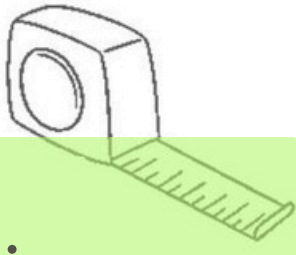

1.

Measure and plan your area to calculate suitable sections to fit the space in your desired layout. If you need help with this call our sales team for advice.

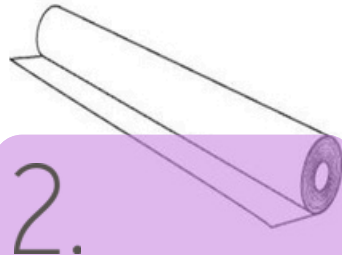

2.

Now you have a list of sections required, choose your back design, fabric and kickboard colour. Select any options eg. Headrolls, Fabric outside back, Back to back kits etc.



3.

Call our Sales team or order online. Our Craftsmen will then manufacture your seating to your specification, carefully package and prepare for dispatch

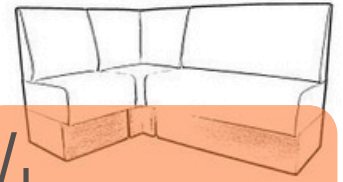

4.

Your seating will be delivered to your doorstep fully assembled ready for you to lay out. The units can be freestanding or clip off front kickboards to secure units together or to the building.

## Standard Module Sizes

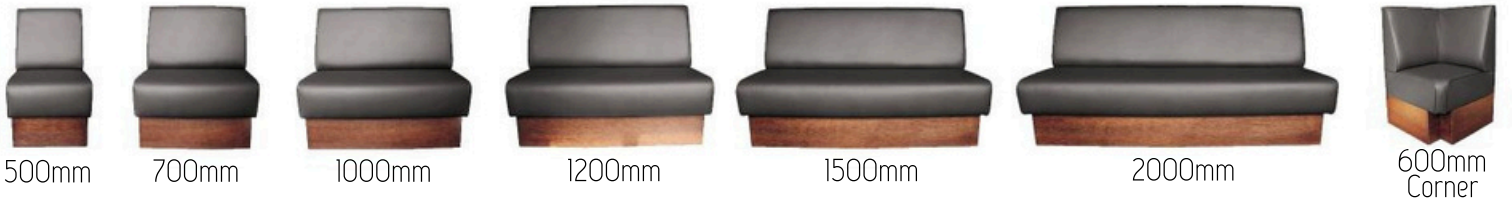

Custom Sizes - If you can't make our standard size fit contact us to discuss a custom size unit or capping kits to fill unwanted gaps.

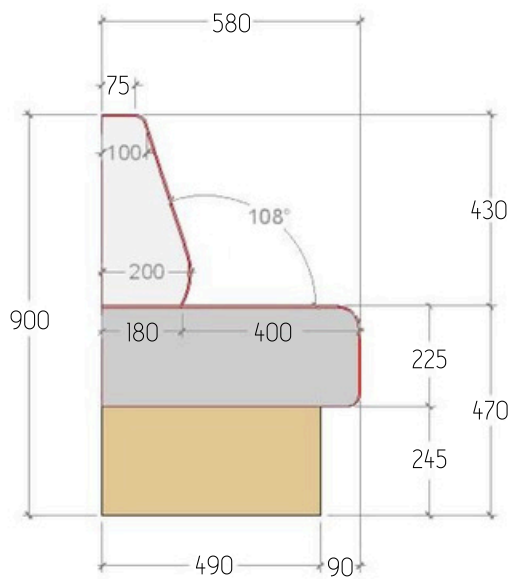

## Layout Ideas

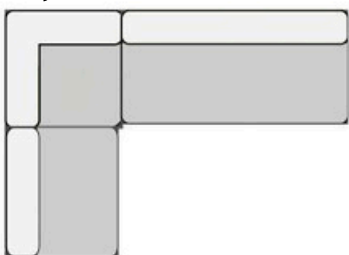

L-Shape

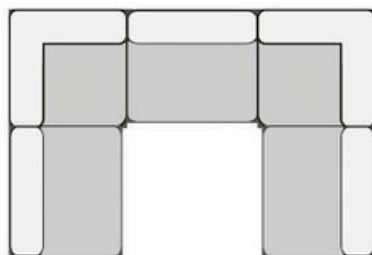

U-Shape



Straights

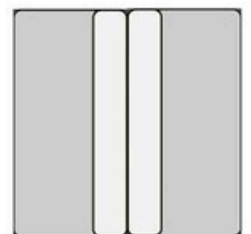

Back to Backs



## Exceptional Quality Unmatched Comfort

Extra Depth

Extra Premium Fabrics

Extra Attention to Detail

Extra-Ordinary

At **Mayfair Furniture**, we specialize in supplying high quality, durable, and stylish furniture designed to meet the demands of businesses. With 16 years of success as a family run company, we understand the importance of reliability, comfort, and aesthetics in commercial spaces.

Our **premium range** is designed for superior comfort with deeper seating and high end craftsmanship. We offer a wide selection of premium fabrics and finishes, ensuring a perfect fit for any professional environment, from hotels and offices to hospitality and corporate spaces.

**Partner with Mayfair Furniture for expertly crafted, long lasting furniture that elevates your business.**

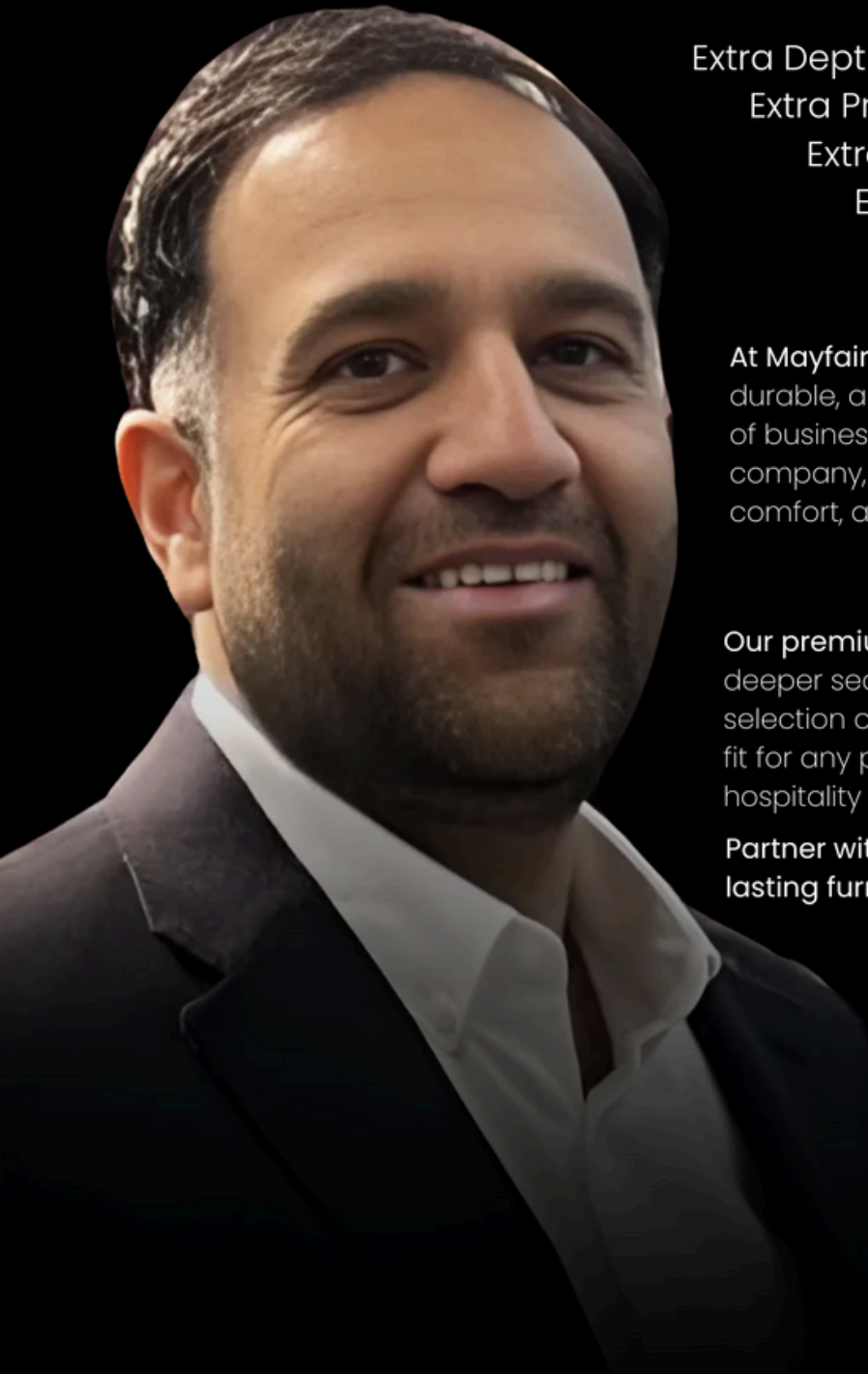

Signature Banquette Seating

# Deep Buttoned Back



Our most technologically advanced seating we have to offer!  
Just look how many buttons it has.....

We can't guarantee any of the buttons do anything but it sure does look pretty.  
Hand pleated and a deeper seat for a more luxurious and relaxed seating position. If you're looking for something extra special you've just found it. This is our most expensive range of seating and you will truly see and feel why.

Available in 3 heights - 900mm, 1100mm & 1300mm  
Includes all our fabric ranges.  
Includes all stains including Signature stains  
Available in same 6x straight lengths as Modular but corner is 650mm x 650mm due to deeper seat.



# Signature Banquette Seating Fluted Back



We've got the Flutes, you bring the Champagne

Fluted upholstery has a simple yet elegant design, giving depth to your furniture with the beautiful curves and striking grooves really sets the style apart from the rest.

Pair this design with one of our faux leathers for an easy clean but elegant look. If you want even more sparkle pair with our Signature Velvets for the ultimate Wow effect.

Available in 3 heights - 900mm, 1100mm & 1300mm

Includes all our fabric ranges.

Includes all stains including Signature stains

Available in same 6x straight lengths as Modular but corner is 650mm x 650mm due to deeper seat.



Signature Banquette Seating

# Plain Back



Beauty can be found in things that are simple, unadorned, and uncomplicated. It is about embracing the elegance of minimalism.

Crisp and clean design makes this seating really stand out, add our optional headroll to make a whole new design and also increasing the height.

Available in 3 heights - 900mm, 1100mm & 1300mm

Includes all our fabric ranges.

Includes all stains including Signature stains

Available in same 6x straight lengths as Modular but corner is 650mm x 650mm due to deeper seat.



Modular Banquette Seating

# American Diner



Comfort the American way with our 50's diner inspired booths.

Build your own American diner with our retro 50's style diner booths, Choose from our most popular colour combinations or make your own from any of the "Just Colour" fabrics.

With traditional contrasting coloured flutes and contrasting piping these booths really scream American nostalgia.



Modular Banquette Seating

# Mill Booths



One from the Bearded, Plaid Wearing  
Wood Workers in the Saw Mill....

Constructed from Solid & Veneered Oak then stained to your choice of colour. Compact footprint to maximise covers.

Available in Singles & Doubles to easily create back to back booths.

Your choice of the shallow or deep seat.

Freestanding and finished on all sides.

Available in 700mm, 1000mm, 1200mm & 1500mm

Dimensions -

Height - 900mm

Depth - 525mm (single) 975mm (double)

Seat Height - 470mm



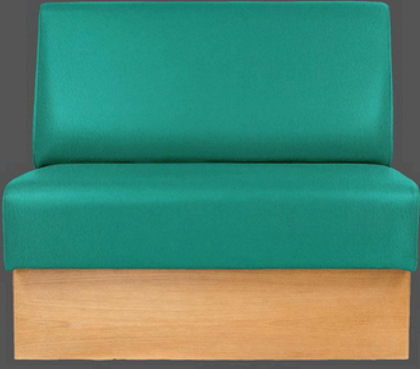

**MAKE IT YOUR OWN**





## Optional Extras



### Headrolls

Want extra height? or maybe that extra WOW factor?

Adding a headroll will definitely achieve that by increasing the overall height by 200mm. Available on all back styles of Modular and Signature Seating, you can mix up the colours for a unique look or use in back to back booths for extra privacy.

### Embroidery

Promote your brand by having it embroidered onto your seating.

Have your logo or name in the background of every picture your customers share on social media for ultimate brand exposure.

We can embroider on the headroll or directly onto the plain back, We can also embroider onto Chairs, Stools, anywhere with flat fabric.



### Float Button

Small details can make all the difference.

Add a row or two of float buttons to your plain back seating. You decide how many buttons you want and distance between them to make it your own.

## Optional Extras

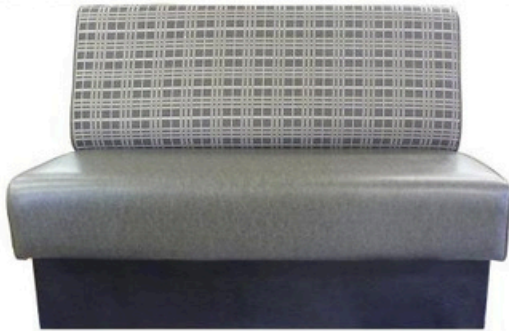

## Custom Fabric

If you're looking for something a little more unique to your taste or want to express your brand then go for a custom fabric.

We have access to 1000's of different fabrics from 100's of suppliers so we will be able to fulfil your requirements.

We can mix the back and seat fabric and even give you contrasting piping and buttons. From plaid to florals, crushed velvets to linens, it is your chance to let your imagination run wild and really create your perfect seating.

## Fabric Outside Back



Standard Outside Back



Optional Fabric Outside Back

As standard, the back of the seating is finished in hardboard similar to the back of a wardrobe, which is perfect if the seating is going against a wall. If your layout requires some or all units to have the backs exposed the Fabric Outside Back option is a must. With this option our upholsterers will cover the outside back in the same fabric as the rest of the seating to ensure the seating is pleasing on the eye from all angles.



## Custom Length

We know it doesn't matter how good you are at Tetris, sometimes our standard units just won't fit. Then you will need a custom size.....

If you're trying to fit between 2 walls or just want to reduce the amount of units needed, we can help.

Call or email our sales team to discuss with your desired measurements. Pricing for custom units is generally priced at the size above then a surcharge to make smaller.



## Optional Extras



## Oak Arm

Finish the end of your seating an optional arm.

Our Oak Arm is a modern version of a pew end, finishes off the end of seating nicely and even gives you a place to rest your arm. Made from an oak veneered panel, Edged with solid oak to make this arm super tough against wear and tear. Stained to match your kickboards. Add one to each end and boom! you have a sofa..... Adds an additional 75mm to the length per arm.

## Fixtures & Fittings

We offer a wide selection of fitting kits to give your seating the finishing touches needed to look exceptional. From back to back kits to make your booths really flow seamlessly to general cappings and radiator cappings. If you have a obstruction or an unusual shape we can make a capping for you. Supplied oversized to be trimmed in and without fittings. Please call our Sales Team to discuss.



## Signature Kickboards

Sticking with the Modular Banquettes but want Signature stains on your kickboards? or want to paint or stain yourself? Either upgrade to Signature stains or ask for RAW kickboards so you can paint or stain to match the rest of your furniture.

# Benches & Stools



# Bench



Simply Stylish.....

Maximise seats with Minimal Space

Our benches are perfect for a minimalist design or for customers looking for maximum seats but are tight on space.

Sit, Straddle, Lay or even try your fanciest gymnastics moves this bench does it all and when not in use can easily slide under the table thanks to nylon glides on the bottom.

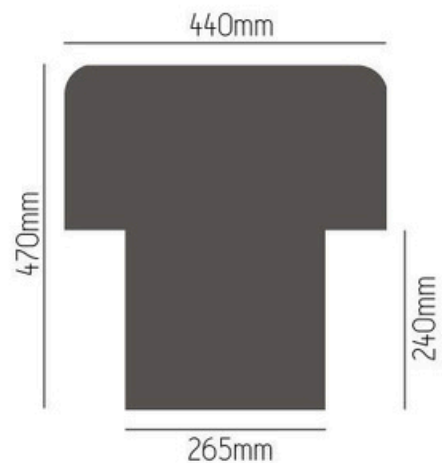

Lengths - 700mm  
1000mm  
1200mm  
1500mm  
Custom\*

# Mia Low & High Stool



Mia Stool Frame, available in 2x heights made from solid Beech.

### Stain Colours -

Standard - Light Golden Oak or Walnut

Signature - Black Ash & Clear Lacquered

Paint - Any Solid Colour or Colour Wash\*\*

Stool Tops sold separately

375mm for high

325mm for low



## Stool Tops

Replace your old scruffy stool tops with these smart new ones or a comfy addition for the Mia stool frame.

Choose your size - 325mm (13") or 375mm (15")

Choose your edge - Piped or Seamed

Choose your Fabric - Cambridge Faux Leather Collection - Standard

Just Colour Range - Optional

Signature Velvets - Optional



Piped Edge

Seamed Edge



## Benches & Stools

# Cubes



**Cube Stools** are an easy & affordable way to add more seats when needed. When not needed can easily be stacked up out the way or tucked under the table. Available as - Plain Top, Deep Buttoned Top or the new Table Top version below.

Fabric Colours -  
Cambridge Faux Leather Collection - Standard  
Just Colours Range - Optional  
Signature Velvets - Optional

Standard - Light Golden Oak or Walnut  
Signature - Black Ash & Clear Lacquered



# Screens



750mm



1200mm



The Wing



## Room Dividers, Privacy Screens or Private Booths

Our screens can divide the room, control traffic flow or give privacy to your customers in a post-Covid world. Available in 750mm or 1200mm wide all standing 1500mm high. or attach "The Wing" to any size screen to create a booth divider. Designed to slide over any of our banquette seating to safely divid off.

When not in use they conveniently stack together using minimal space. Available in - Light Golden Oak, Walnut or Black Ash to match the rest of our furntiure.



# Inspiration